

# 5x7 PORTRAIT POCKET FOLD

5x7 card stock (actual measurement 5.125 x 7.125) - no cutting

5x7 card stock cut to 4.75 x 6.75

5x7 card stock cut to 4.5 x 6.5

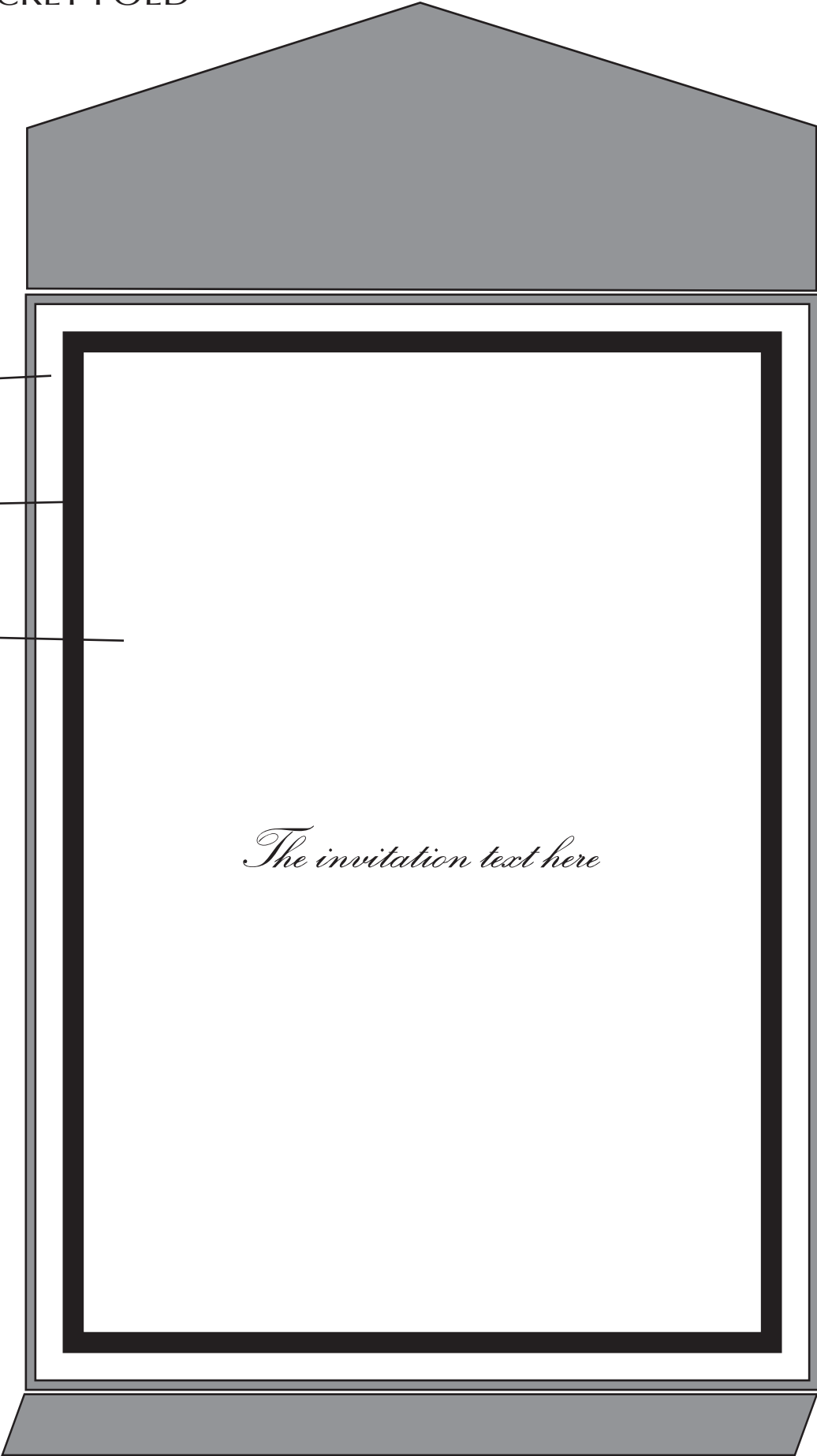

*The invitation text here*

# 5x7 PORTAIT POCKET FOLD

## 3 cards in pocket

Response (rsvp) cards that will be going into an envelope must fit one of the envelope sizes. Typically the 3.5 x 5 envelope is used (actual measurements of the envelope 3.625 x 5.125). The other possibility is the 4x5 envelope (actual measurements 4.375 x 5.75).

5x7 card stock cut to  
4.875 x 7

5x7 card stock cut to  
4.625 x 6.75

5x7 card stock cut to  
4.875 x 5.5

5x7 card stock cut to  
4.625 x 5.25

5x3.5 card stock cut  
to 4.875 x 3.5

5x3.5 card stock cut  
to 4.625 x 3.25

typical size tag  
for 5x7 pocket fold

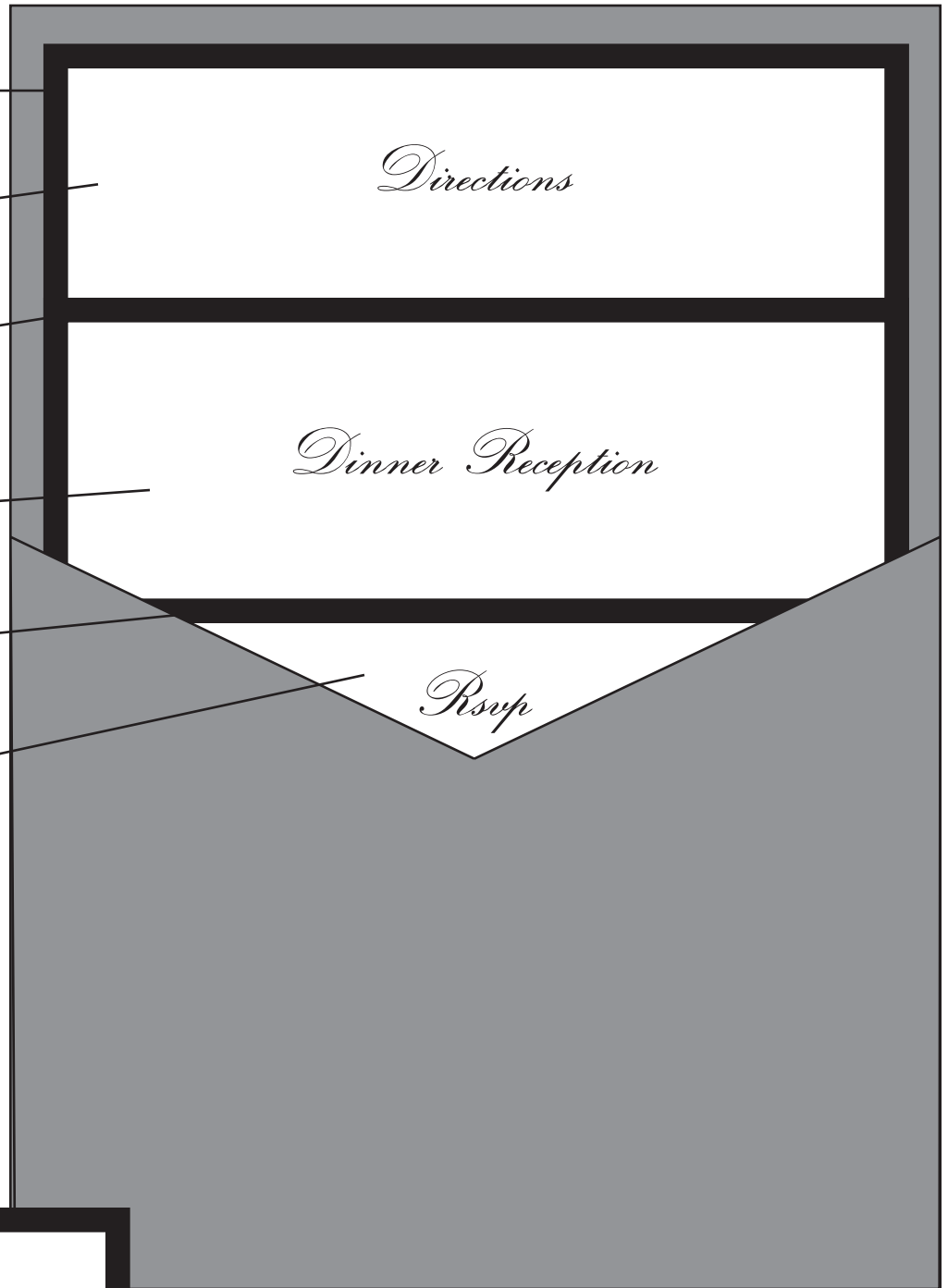

Cards shown in pocket

You place rsvp envelope behind the other cards and  
only push the rsvp card partially into the pocket

3.5x5 card stock cut to 3.25 x 2.25

3.5x5 card stock cut to 3 x 2

# 5x7 PORTAIT POCKET FOLD

4 cards in pocket

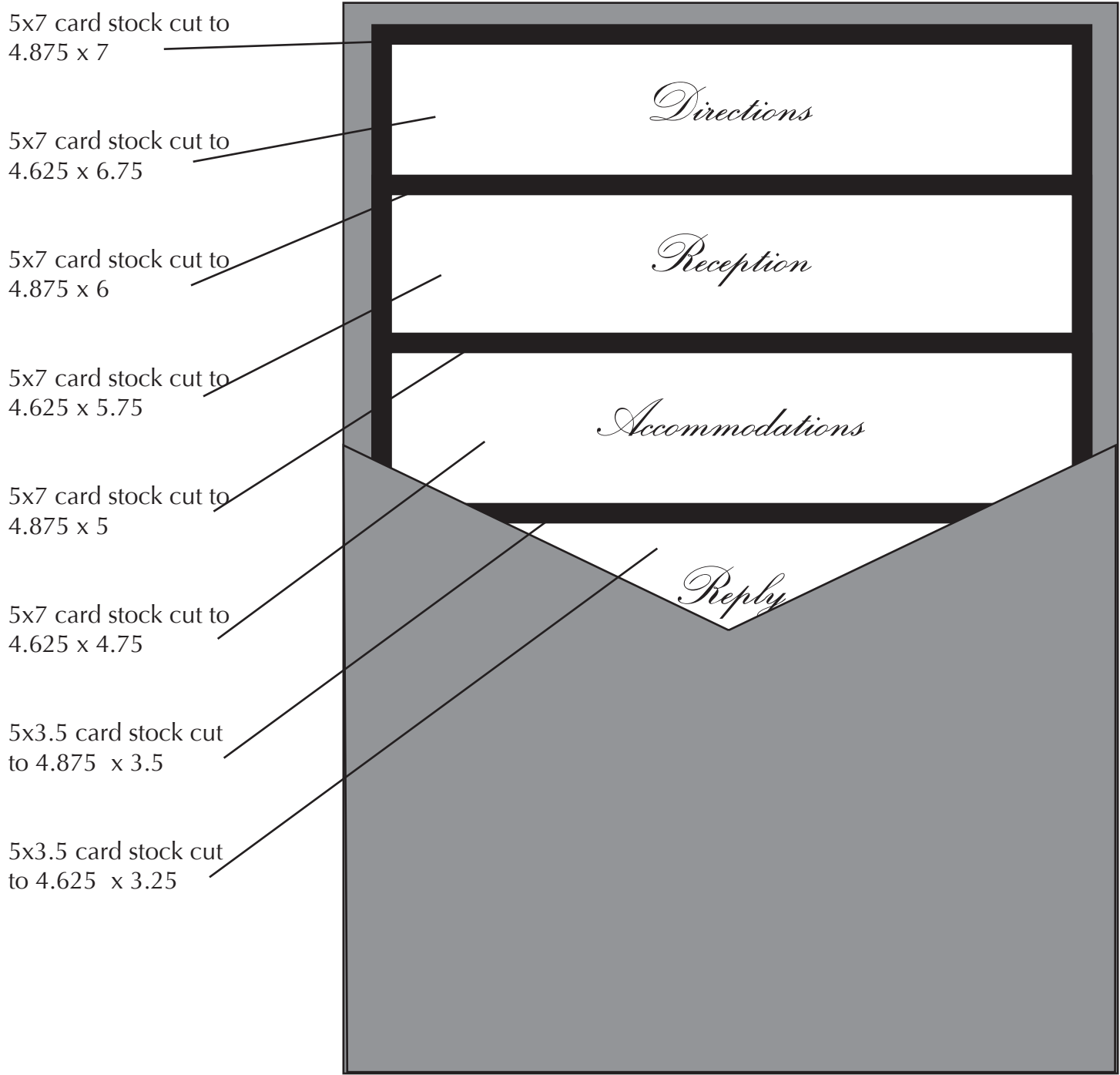

Cards shown in pocket  
You place rsvp envelope behind the other cards and only push the rsvp card partially into the pocket

# 5x7 PORTAIT POCKET FOLD

4 cards in pocket

5x7 card stock  
cut to 4.875 x  
6.625

5x7 card stock cut to  
4.625 x 6.125

5x7 card stock cut to  
4.875 x 5.625

3.5x5 card stock  
(not cut)

3.5x5 envelope

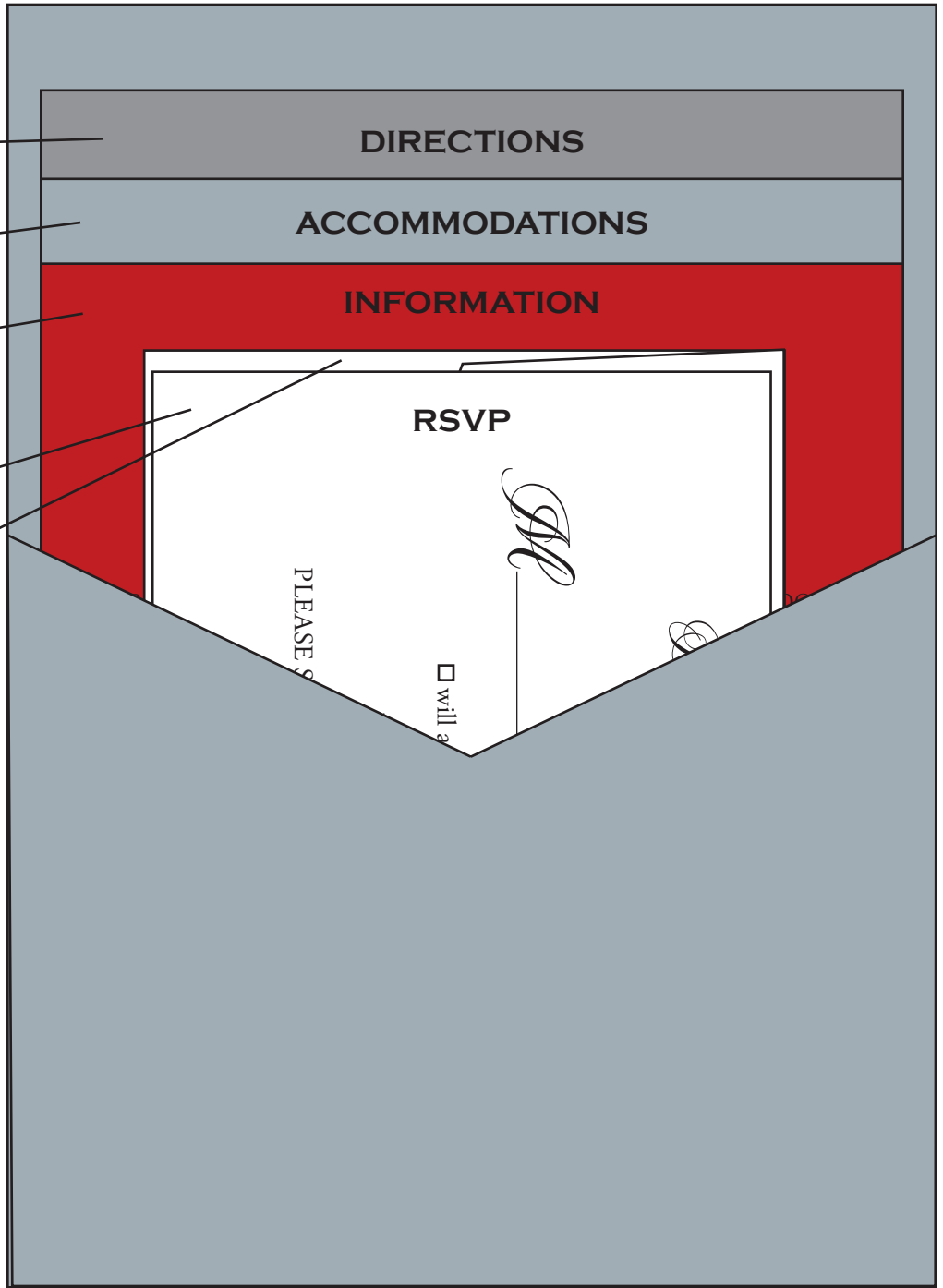

# 5x7 PORTAIT POCKET FOLD with reply post card

A word about rsvp post cards... The US Postal system will not accept post cards that have more than one layer (so no backings). In order to use post card postage the smallest size allowed is 3.5 x 5. the largest is 4.25 x 6  
Post card MUST be rectangles.

5x7 card stock  
cut to 4.875 x 7

5x7 card stock  
cut to 4.625 x 6.75

5x7 card stock  
cut to 4.25 x 6

4x5 card stock  
cut to 3.625 x 5

4x5 card stock  
cut to 3.375 x 4.75

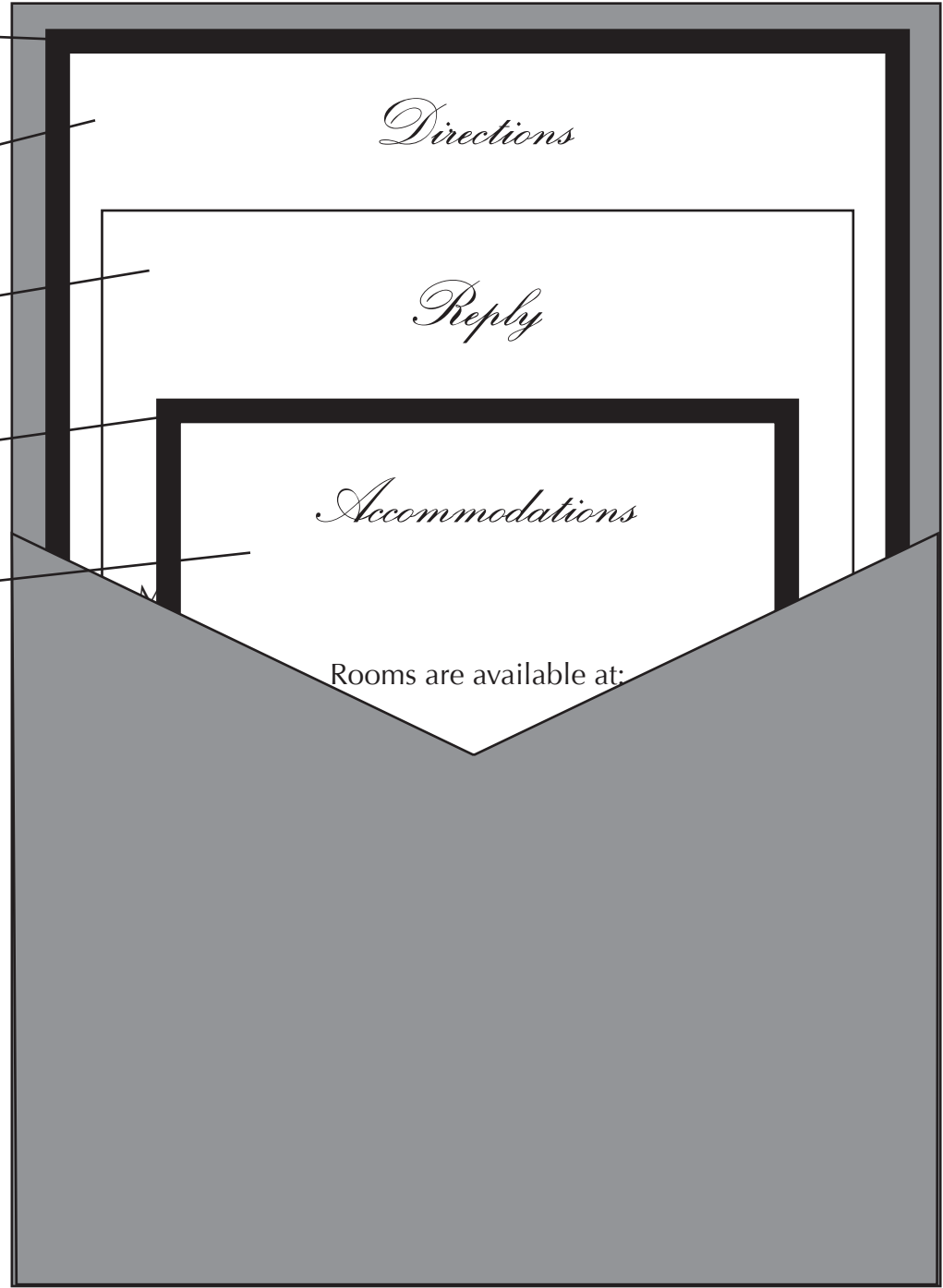

# 5x7 LANDSCAPE POCKET FOLD

5x7 card stock  
(actual measurement  
5.125 x 7.125) - no cutting

5x7 card stock  
cut to 4.75 x 6.75

5x7 card stock  
cut to 4.5 x 6.5

5x7 card stock cut to 5 x 7  
5x7 card stock cut to 4.75 x 6.75

5x7 card stock cut to 4.25 x 6  
5x7 card stock cut to 4 x 5.75

3.5 x 5 card stock  
3.5 x 5 card stock cut to 3.25 x 4.75

3.5 x 5 card stock cut to 2.75 x 4  
3.5 x 5 card stock cut to 2.5 x 3.75

*Directions*

*Reception*

*Reply*

Head  
Corner  
Take  
Turn

card.  
les.  
mi.  
otel

# 5x7 SIGNATURE SIDE POCKET FOLD



5x7 card stock (actual measurement  
5.125 x 7.125) - no cutting

5x7 card stock cut to 4.75 x 6.75

5x7 card stock cut to 4.5 x 6.5

*The invitation text here*

*Directions*

*Reception*

*Accommodations*

*Reply*

# 5x7 SIGNATURE SIDE POCKET FOLD

4 cards in pocket

5x7 card stock cut to  
4.75 x 7

5x7 card stock cut to  
4.5 x 6.75

5x7 card stock cut to  
4.75 x 6

5x7 card stock cut to  
4.5 x 5.75

5x7 card stock cut to  
4.75 x 5

5x7 card stock cut to  
4.5 x 4.75

5x3.5 card stock cut  
to 4.75 x 3.5

5x3.5 card stock cut  
to 4.5 x 3.25

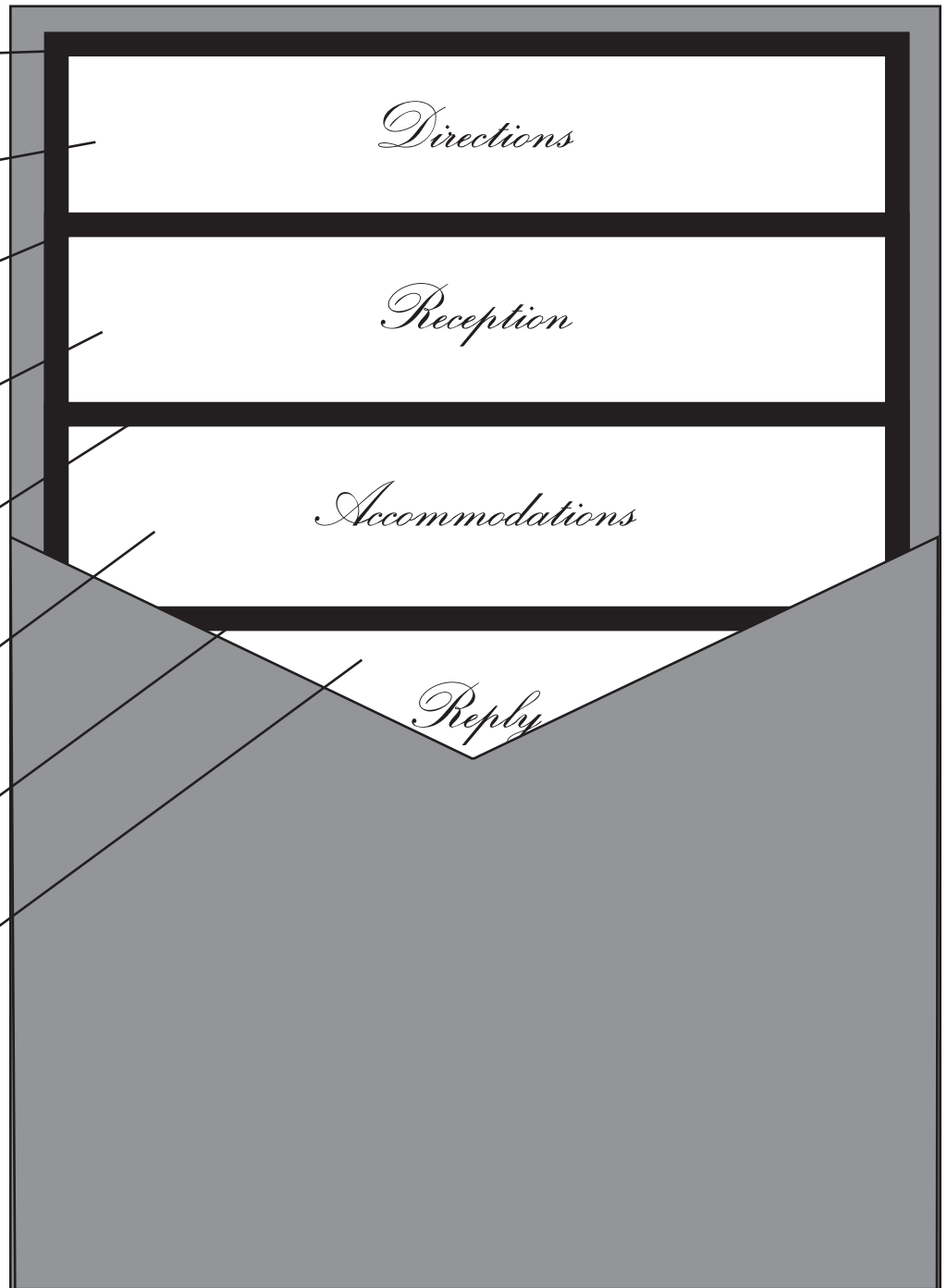

Cards shown in pocket

You place rsvp envelope behind the other cards and  
only push the rsvp card partially into the pocket

5x5 SIGNATURE SIDE POCKET FOLD (\* the same measurements work for the 5x5 signature pocket fold and the 5x5 booklet pocket fold)

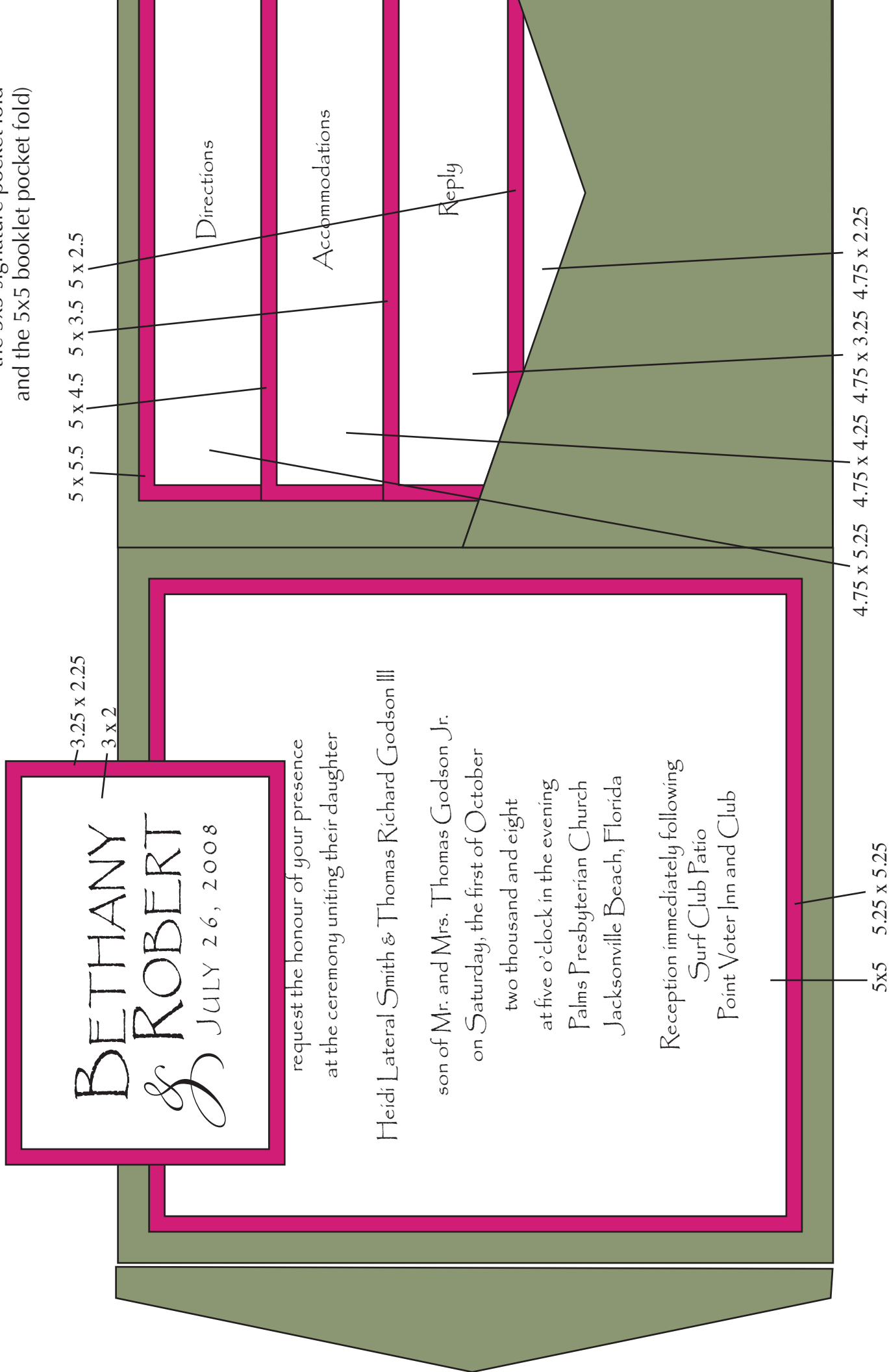

## 7x7 POCKET FOLD

7x7 card stock (actual measurement 7.125 x 7.125) - no cutting

5x5 card stock (actual measurement 5.25 x 5.25) - no cutting

5x5 card stock cut to 5x5

*Directions*

*Reply*

*Reception*

From Ne  
Le Lit

low signs  
st t

# 7x7 POCKET FOLD

## 3 cards in pocket

Response (rsvp) cards that will be going into an envelope must fit one of the envelope sizes. Typically the 3.5 x 5 envelope is used (actual measurements of the envelope 3.625 x 5.125). The other possibility is the 4x5 envelope (actual measurements 4.375 x 5.75).

5x7 card stock cut to  
4.25 x 7

5x7 card stock cut to  
4 x 6.75

3.5 x 5 rsvp envelope

3.5x5 card stock

3.5x5 card stock cut  
to 3.25 x 4.75

3.5x5 card stock cut  
to 2.75 x 4

3.5x5 card stock cut  
to 2.5 x 3.75

typical size tag  
for 5x7 pocket fold



3.5x5 card stock cut to 3.25 x 2.25

3.5x5 card stock cut to 3 x 2

# 7x7 POCKET FOLD

## 3 cards in pocket

Response (rsvp) cards that will be going into an envelope must fit one of the envelope sizes. Typically the 3.5 x 5 envelope is used (actual measurements of the envelope 3.625 x 5.125). The other possibility is the 4x5 envelope (actual measurements 4.375 x 5.75).

3.5x5 card stock cut to 4.25 x 3.5

5x7 card stock cut to 4.25 x 5.5

5x7 card stock cut to 4.25 x 7

3.5 x 5 rsvp envelope

3.5x5 card stock

typical size tag for 5x7 pocket fold

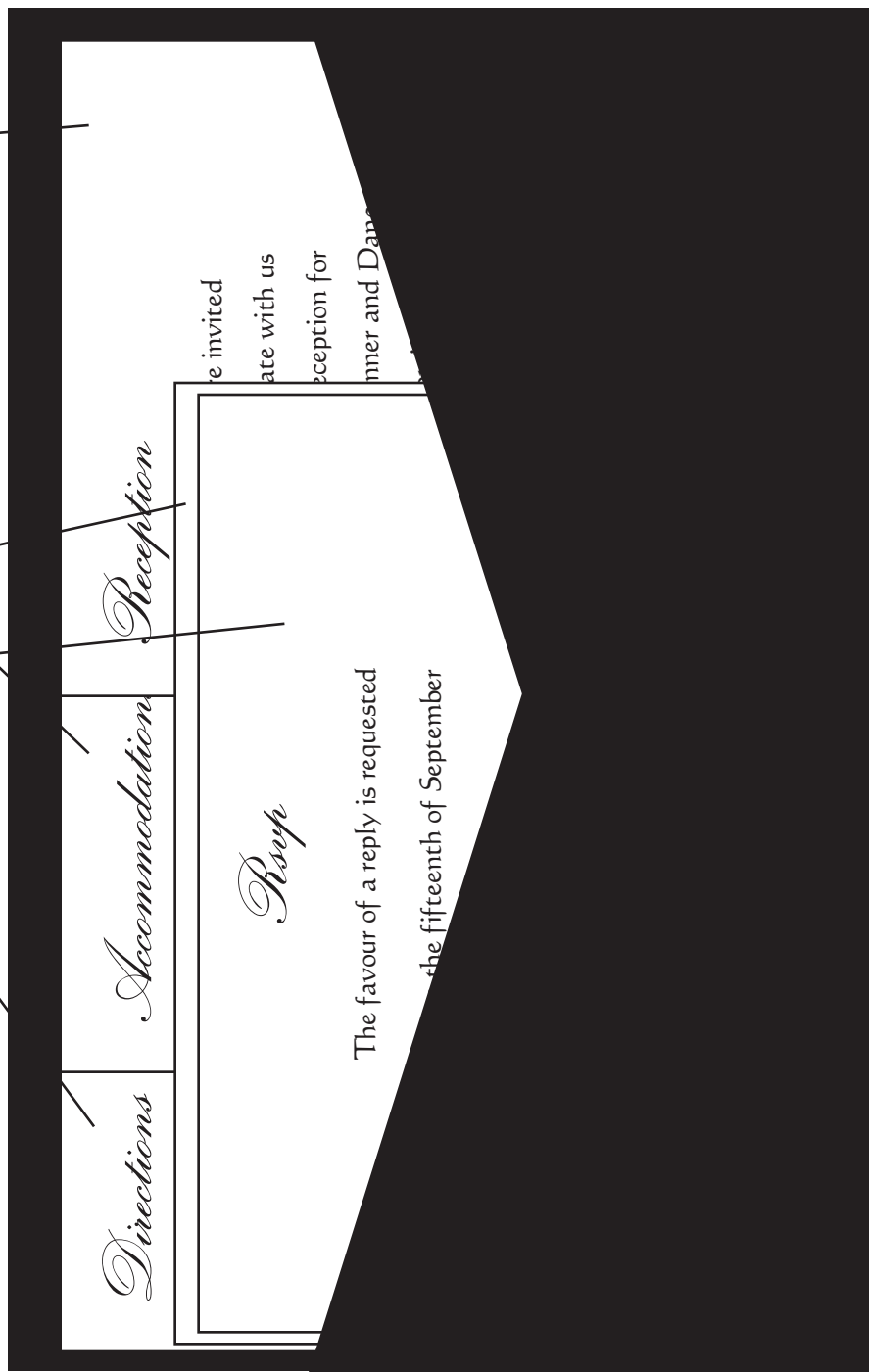

3.5x5 card stock cut to 3.25 x 2.25

3.5x5 card stock cut to 3 x 2

4x9 card stock  
actual measurement 3.875 x 8.875)  
no cutting

4x9 card stock cut to 8.5 x 3.5

4x9 card stock cut to 8.25 x 3.25

4x9 card stock cut to 8.875 x 3.5

4x9 card stock cut to 8.625 x 3.25

4x9 card stock cut to 6.75 x 3.5

4x9 card stock cut to 6.5 x 3.25

3.5 x 5 card stock - no cutting

3.5 x 5 card stock cut to 3.25 x 4.75

3.5 x 5 card stock cut to 3.25 x 3.5

3.5 x 5 card stock cut to 3 x 3.25

typical size tag



*Direction*

*Dinner*

*Reply*

*Hotel*

M

3.5x5 card stock cut to 3.25 x 2.25

3.5x5 card stock cut to 3 x 2

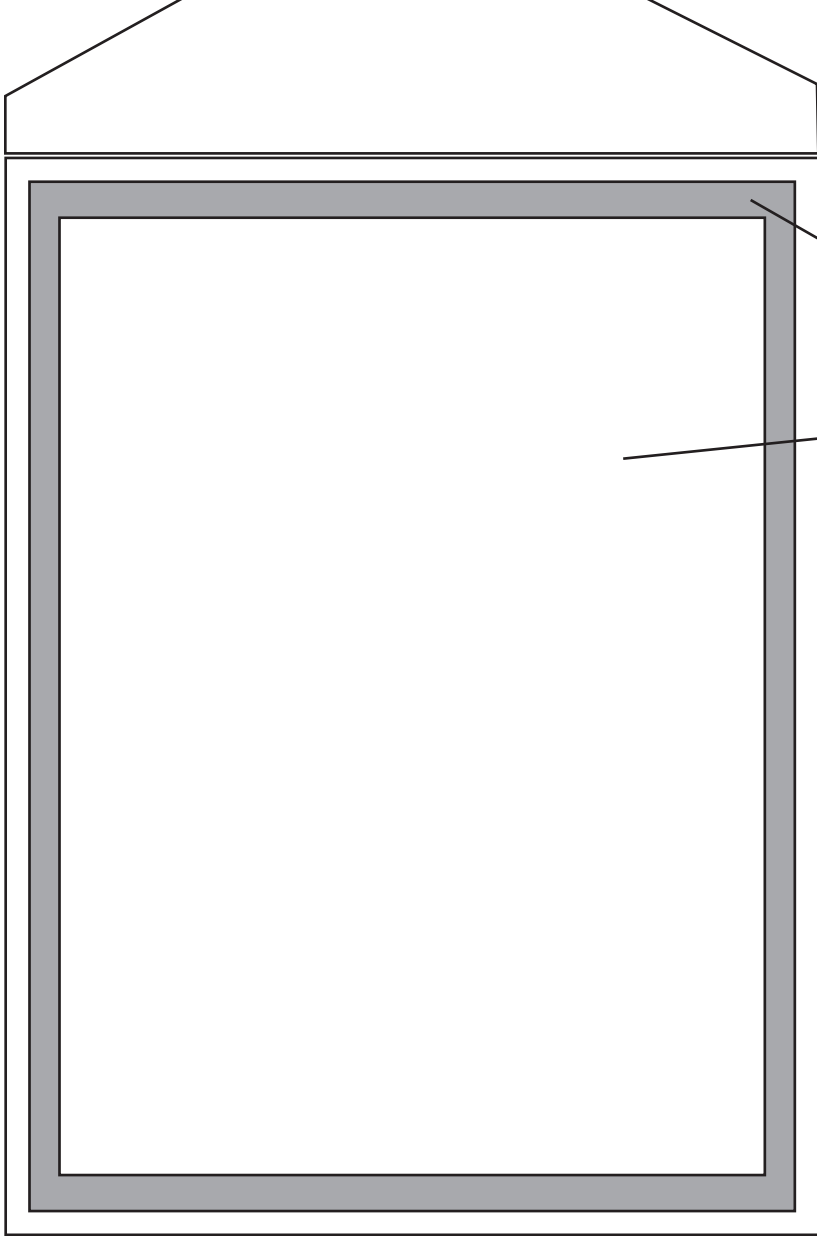

4x5 card stock  
actual measurement 4 x 5.375)  
no cutting

4x5 card stock cut to 3.6875 x 5

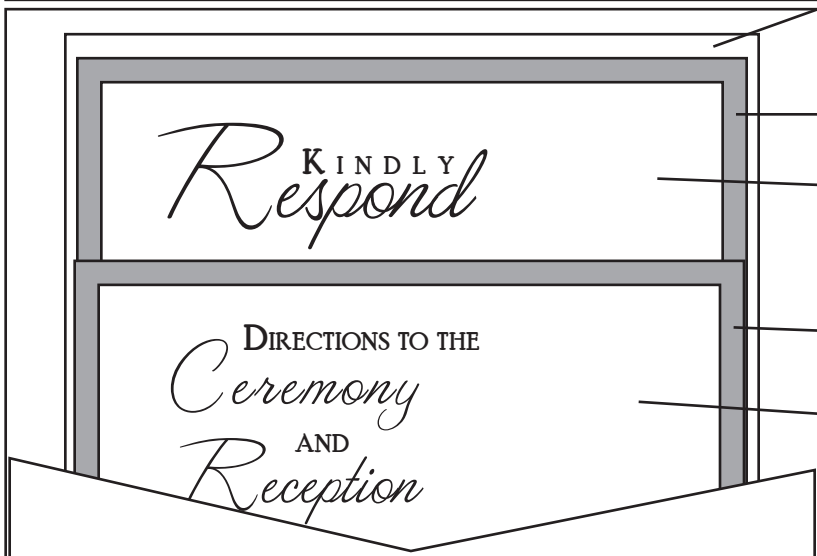

3.5 x 5 rsvp envelope  
actual measurement 3.625 x 5.125

3.5 x 5 card stock - no cutting

3.5 x 5 card stock cut to 3.25 x 4.75

3.5 x 5 card stock cut to 4 x 3.5

3.5 x 5 card stock cut to 3.75 x 3.25

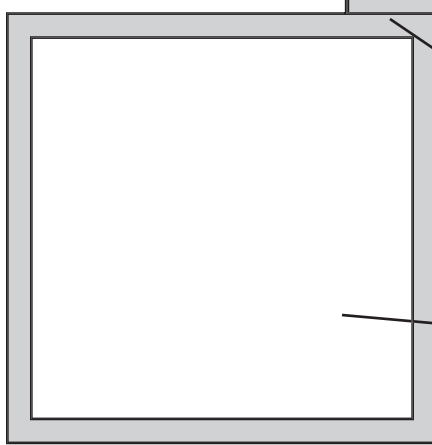
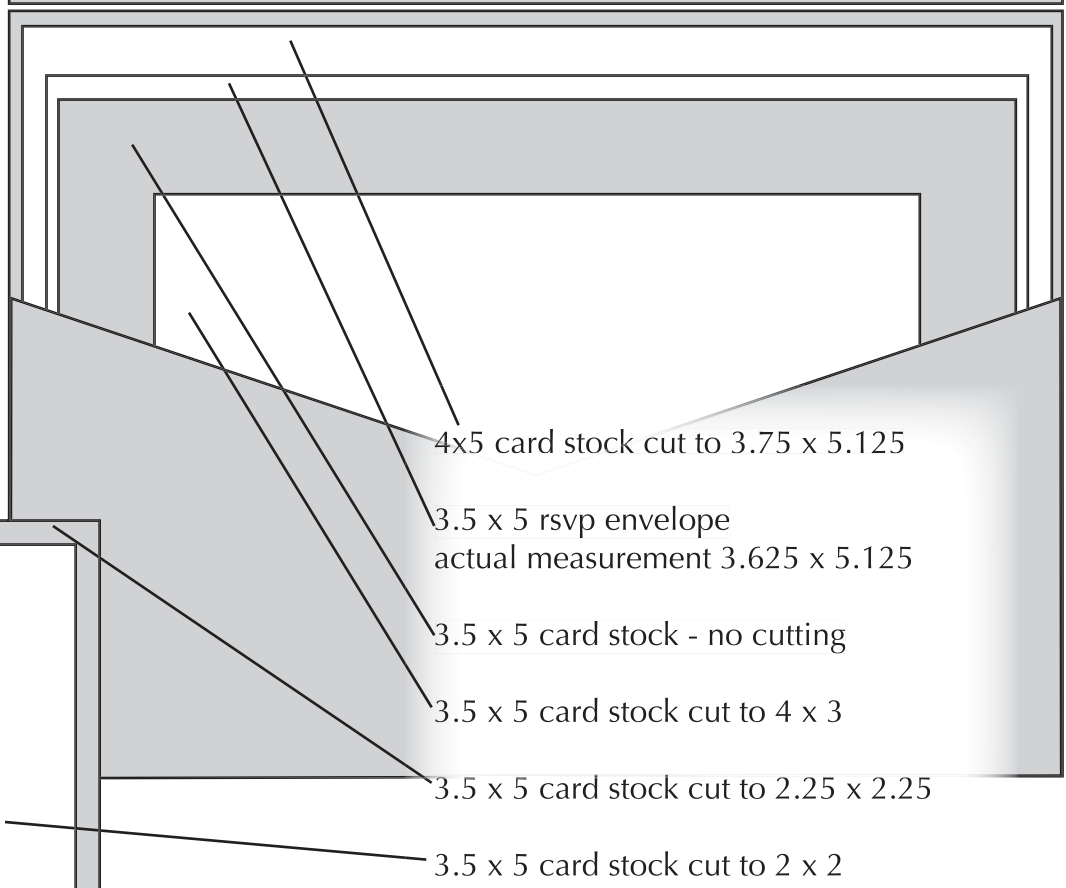
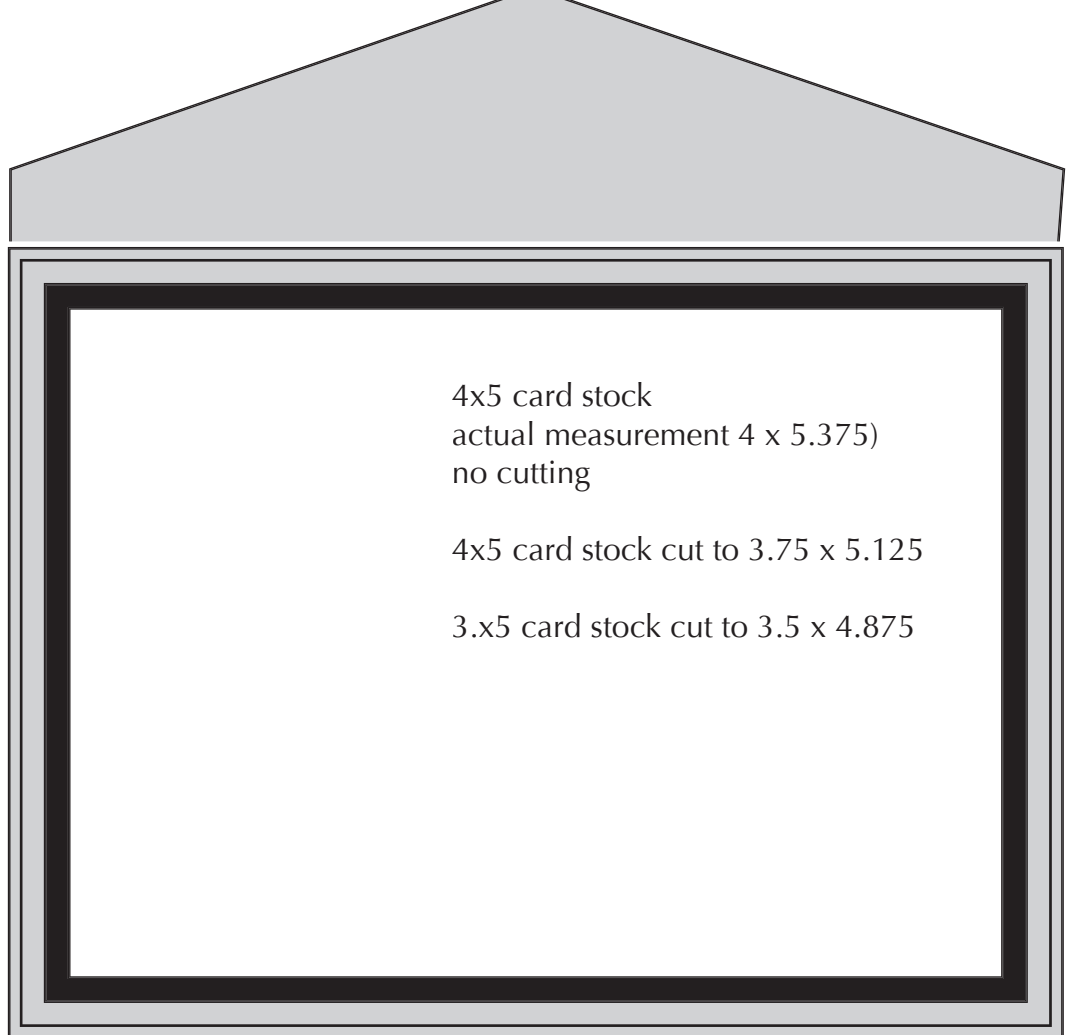

# 5x7 ENVELOFOLD



5x7 card stock (actual measurement 5.125 x 7.125) - no cutting

5x7 card stock cut to 4.75 x 6.75

5x7 card stock cut to 4.5 x 6.5

*The invitation text here*